

FAST HIGH VOLTAGE TRANSISTOR SWITCHES

Features

- Nanoseconds Rise Time
- Very Large di/dt
- Low Turn-On Jitter
- Short Delay Time
- High Frequencies
- Low Trigger Voltage
- Galvanic Isolation
- Reliable Switching

Applications

- HV Pulse Generators
- Pockels Cell Drivers
- Power Tube Drivers
- Deflection Grid Drivers
- Crowbar Switches
- EMC Test Equipment
- Radar Modulators
- Laser Electronics

HTS 20-08 2000 VOLTS / 80 AMPS
HTS 30-06 3000 VOLTS / 60 AMPS
HTS 50-06 5000 VOLTS / 60 AMPS

HIGH VOLTAGE / HIGH CURRENT
 WITH FIXED ON-TIME

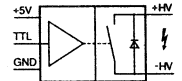

- Patented -

DESCRIPTION

These switches are designed for high voltage, high current switching applications in which loads of very low impedances (e.g. large capacitances) must be driven with very short transition times. Compared to conventional high voltage switches using cold cathode tubes, thyratrons or spark gaps, the solid state switches of model series HTS have a very short recovery time, a high repetition rate, low jitter and a lifetime typical for semiconductor devices. Because of the TTL-compatible trigger input, HTS-switches require no complex drive circuitry and no high auxiliary voltages. The switches described in this data sheet have a fixed on-duration of 150 nanoseconds which can be extended optionally up to 100 microseconds. Due to the galvanic isolation of more than 10 KVDC, positive as well as negative voltages can be switched on or off, the switches can also be floated at a high potential.

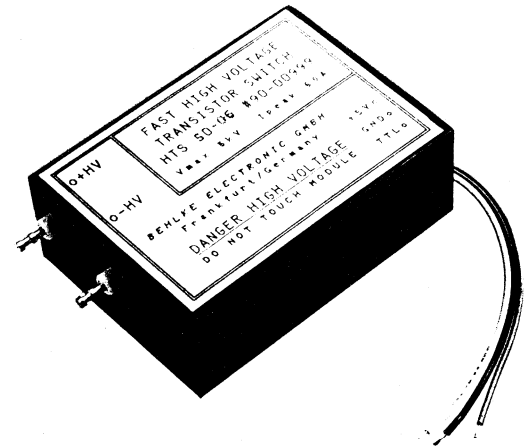

SPECIFICATION	SYMBOL	CONDITION / COMMENT	20-08	30-06	50-06	UNIT
Max. Operating Voltage	V_0	$I_{off} \leq 100 \mu A$	2000	3000	5000	VDC
Isolation Strength	V_I	Continuously	>10000	>10000	>10000	VDC
Max. Peak Current	$I_{P(max)}$	$t_p \leq 50 \text{ ns}$	80	60	60	ADC
Static On-Resistance	R_{stat}	$I_L = 0.1 \times I_{P(max)}$	1	3	5	Ohm
Max. Off-State Current	I_{off}	$0.8 \times V_0$	10	10	10	μADC
Turn-On Delay Time	$t_{d(on)}$	At $I_{P(max)}$	50	50	50	ns
Turn-On Rise Time	$t_{r(on)}$	$I_L = 0.1 \times I_{P(max)}, V_0 = 2 \text{ kVDC}$	5	4.5	4.0	ns
		$I_L = I_{P(max)}, V_0 = 2 \text{ kVDC}$	15	14	15	ns
On-Time	t_{on}	-20...+10%		150		ns
Recovery Time	t_{rc}	(Min. Pulse Spacing)		300		ns
Typical Turn-On Jitter	$t_{j(on)}$	$V_{aux} = 5,0 \text{ VDC}, f = 10 \text{ kHz}$		100		ps
Max. Switching Frequency	$f_{(max)}$	Continuously	25	40	25	kHz
Cont. Power Dissipation	$P_{d(max)}$	$T_{case} \leq 25 \text{ }^\circ\text{C}$	15	10	15	Watts
Derating		Above $25 \text{ }^\circ\text{C}$		0.3		W/°C
Temperature Range	T_0			-10...60		°C
Auxiliary Supply Voltage	V_{aux}	$\pm 5\%$		5.0		VDC
Auxiliary Supply Current	I_{aux}	$f = f_{(max)}$		300		mA DC
Trigger Signal Voltage	V_{tr}	> 3 VDC recommended		2...10		VDC
Dimensions				70x50x27		mm ³
Weight				160		g

All data and specifications subject to change without notice. Custom designed devices on request.

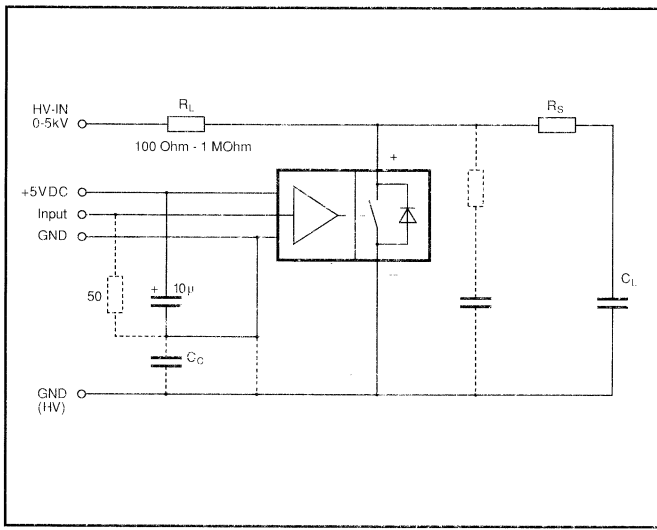

Fig. 2a: Example of Connection

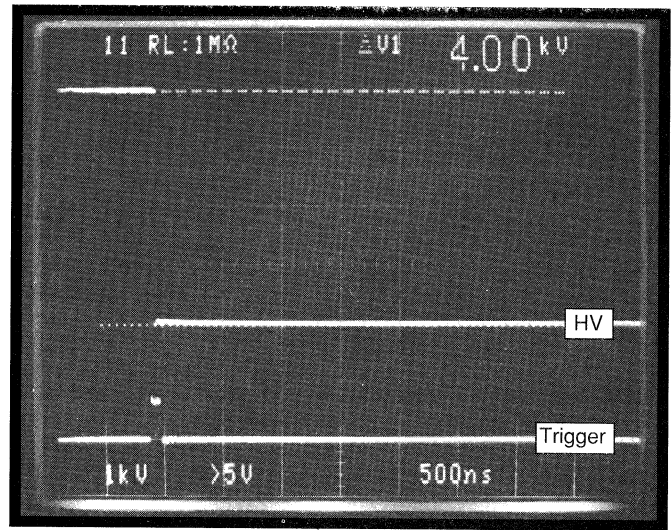

Fig. 2c: Pulse Shape, $R_L = 1M\Omega$; $C_L = 30pF$; 1kV/div.

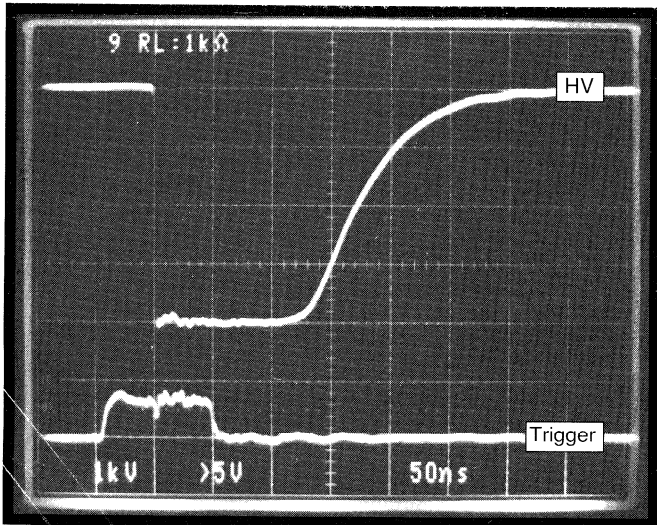

Fig. 2b: Pulse Shape, $R_L = 1k\Omega$; $C_L = 30pF$; 1kV/div.

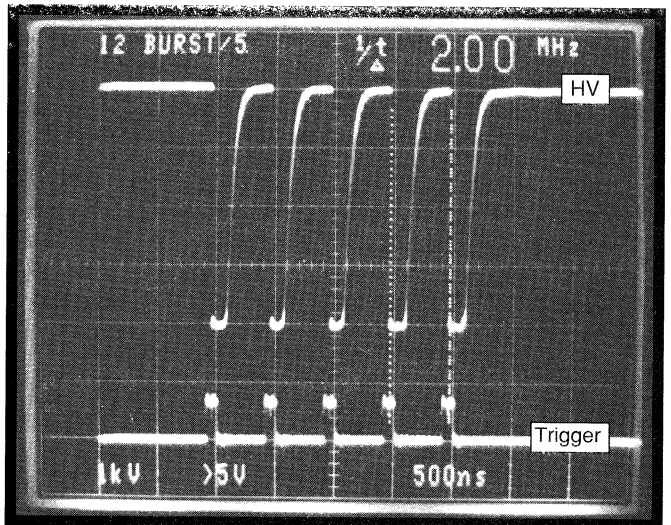

Fig. 2e: 2 MHz-Burst, $R_L = 1k\Omega$; 1kV/div.

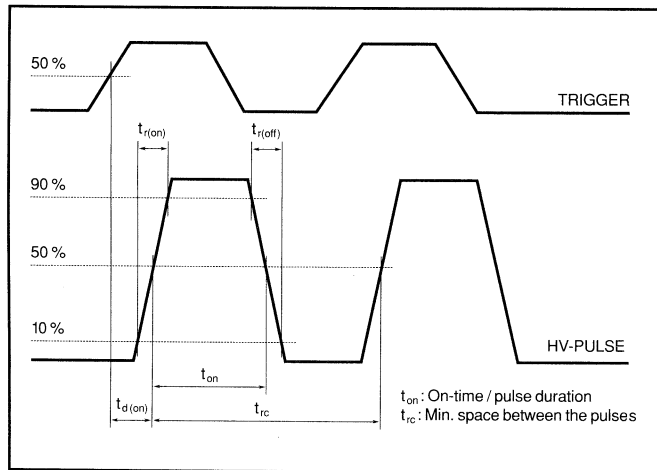

Fig. 5: Definition of pulse parameters

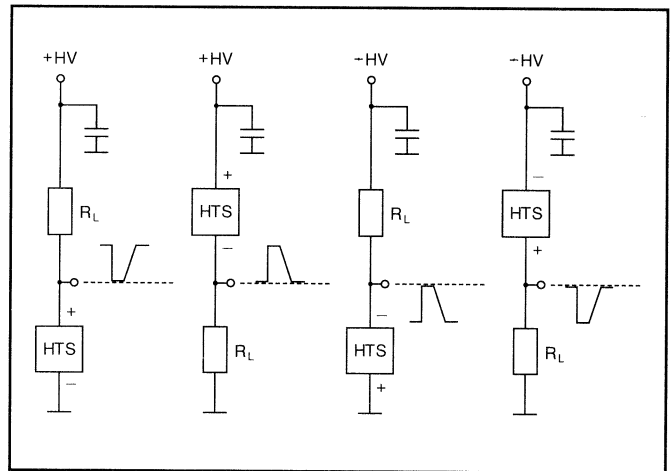

Fig. 4: Basic Circuit Configurations

Ordering Information:

- HTS 20-08 Transistor Switch, 2kV/80A/150ns
- HTS 30-06 Transistor Switch, 3kV/60A/150ns
- HTS 50-06 Transistor Switch, 5kV/60A/150ns
- Option 01 On-Time Extension, 1 μ s, \pm 30%
- Option 02 On-Time Extension, 10 μ s, \pm 30%
- Option 03 On-Time Extension, 100 μ s, \pm 30%
- Option 04 Custom designed On-Time
- Option 05 High Frequency Burst
- Option 06 UL-94-VO Casting Resin

Local Sales Representative